

Study of Crosstalk Propagation in All-Optical Networks using Perturbation Theory

Yvan Pointurier and Maité Brandt-Pearce
{yvan, mb-p}@virginia.edu

Charles L. Brown Department of
Electrical and Computer Engineering
University of Virginia, USA

IEEE ICECS'05, December 2005

Overview

- ▷ Introduction
 - All-optical networks
 - Crosstalk
 - Modeling and problem statement
- ▷ Analysis
- ▷ Validation by simulation
- ▷ Conclusion

All-optical networks

- ▷ Current high-speed optical networks
 - Bottleneck due to electrical conversions
- ▷ Features of all-optical networks
 - Speed, flexibility, cost
- ▷ New issues arise with all-optical networks
 - Nodes (OXCs) are subject to crosstalk
 - Crosstalk is transmitted over extremely long paths without electrical signal regeneration → nonlinear interaction
- ▷ Implementation
 - Crosstalk issues not all encountered yet

OXC (all-optical switch) and crosstalk

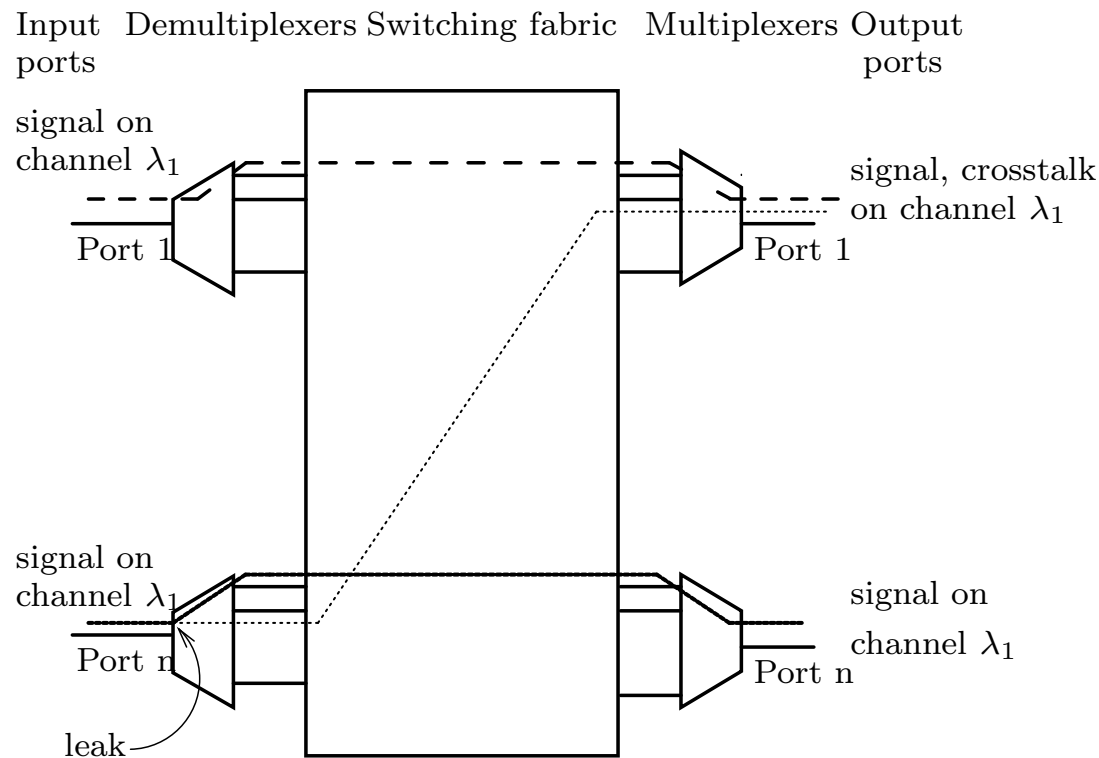

- ▷ Leaks can originate from imperfect demultiplexing, or transmission within the switching matrix

Lightpath and physical layer models

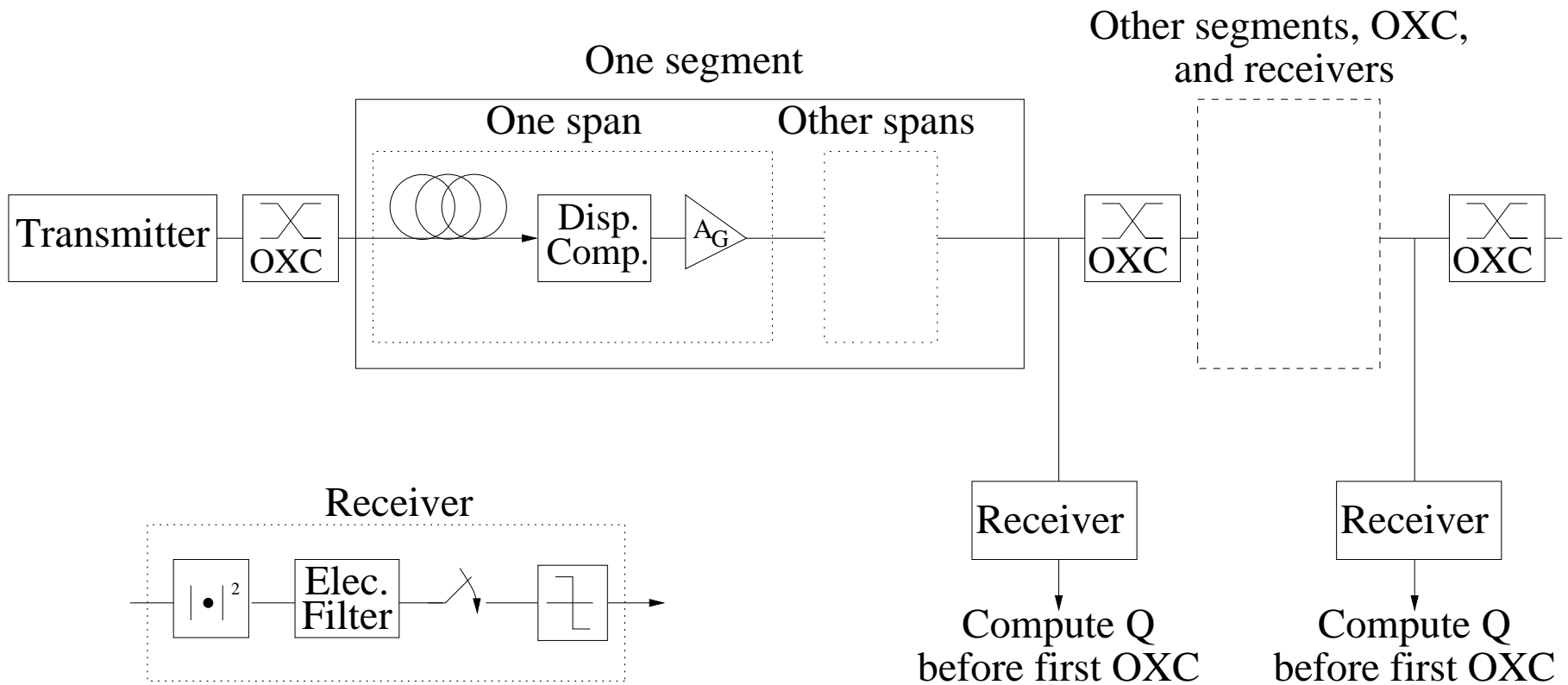

$$BER = \frac{1}{2} \operatorname{erfc} \frac{Q}{\sqrt{2}}, \quad Q = \frac{\mu_1 - \mu_0}{\sigma_0 + \sqrt{\sigma_i^2 + \sigma_n^2 + \sum \sigma_x^2}}$$

Crosstalk model

$$\triangleright s_0(t) = s_m(t) + \sum_{\ell} m_{\ell} g_0(t - \ell T_b)$$

- **in the analysis only**, $s_m(t)$ is assumed to be a Continuous Wave (CW): $s_m(t) = \sqrt{P_0}$
- $s_m(t)$ is modulated in the simulations
- Crosstalk signal is modulated (analysis and simulations)

$$\triangleright g_0(t) = \sqrt{\eta P_0} h(t - \tau) e^{j\omega_s(t - \tau) + j\varphi}$$

- Bits m_{ℓ} , delay τ and phase φ are uniformly distributed over $\{0,1\}$, $[0, T_b)$, $[0, 2\pi)$, respectively.
- Crosstalk attenuation η , detuning ω_s
- Pulse shape $h(t)$

Problem statement

▷ What is the impact of crosstalk and how does it depend on the physical parameters ?

- $$Q = \frac{\mu_1 - \mu_0}{\sigma_0 + \sqrt{\sigma_i^2 + \sigma_n^2 + \sum \sigma_x^2}}$$

- Simulations are very slow (tens of hours) because of the number of random parameters
- Can compute μ_0 , μ_1 , σ_0 , σ_i using very short simulations of a few bits (ISI, linear and nonlinear signal transmission effects)
- Can compute σ_n due to noise using analytical techniques
- Need a fast way to compute σ_x and hence Q

Overview

- ▷ Introduction
- ▷ **Analysis**
- ▷ Validation by simulation
- ▷ Conclusion

Determining a transfer matrix

▷ CW input, after k spans:

$$s_m(t, L) = e^{jk\theta_{SPM}} \sqrt{P_0} \quad \text{with} \quad (\theta_{SPM} \approx -\gamma P_0/\alpha)$$

▷ Crosstalk bit, after k spans:

$$g_k(t) = e^{jk\theta_{SPM}} (g_k^I(t) + jg_k^Q(t))$$

▷ Projecting:

$$g_k^I(t) = g_k^{I+}(t)e^{j\varphi} + g_k^{I-}(t)e^{-j\varphi}$$

$$g_k^Q(t) = g_k^{Q+}(t)e^{j\varphi} + g_k^{Q-}(t)e^{-j\varphi}$$

Continued ...

▷ In frequency domain, for the first span (same for I-/Q- terms):

$$\begin{bmatrix} G_1^{I+}(\omega) \\ G_1^{Q+}(\omega) \end{bmatrix} = T_1(\omega) \begin{bmatrix} G_0^{I+}(\omega) \\ G_0^{Q+}(\omega) \end{bmatrix}$$

▷ After k spans (same for I-/Q- terms):

$$\begin{bmatrix} G_k^{I+}(\omega) \\ G_k^{Q+}(\omega) \end{bmatrix} = T_k(\omega) \dots T_1(\omega) \begin{bmatrix} G_0^{I+}(\omega) \\ G_0^{Q+}(\omega) \end{bmatrix}$$

Contents of the transfer matrix

$$T_k(\omega) = \underbrace{\begin{bmatrix} \frac{1}{2}e^{-j\theta_{SPM}} & \frac{1}{2}e^{j\theta_{SPM}} \\ \frac{1}{2j}e^{-j\theta_{SPM}} & -\frac{1}{2j}e^{j\theta_{SPM}} \end{bmatrix}}_{\text{SPM}} \underbrace{\mathcal{D}(\omega)}_{\text{disp. comp.}} \underbrace{\mathcal{M}_k(\omega)}_{\text{disp. and NL}} \begin{bmatrix} 1 & j \\ 1 & -j \end{bmatrix}$$

$$\mathcal{M}_k(\omega) = \begin{bmatrix} \mathcal{M}_{1,1}(\omega) & \mathcal{M}_{1,2}(\omega) \\ \mathcal{M}_{1,2}^*(\omega) & \mathcal{M}_{1,1}^*(\omega) \end{bmatrix}$$

$$\mathcal{M}_{1,1}(\omega) = e^{-\frac{\alpha}{2}L} G e^{-\frac{j}{2}(\beta_2 L)\omega^2} \left(1 - j \frac{2\gamma P_0}{\alpha} + \frac{\gamma^2 P_0^2}{2\alpha(\alpha - j\beta_2 \omega^2)} - \frac{2\gamma^2 P_0^2}{\alpha^2} \right)$$

$$\mathcal{M}_{1,2}(\omega) = e^{-\frac{\alpha}{2}L} G e^{-\frac{j}{2}(\beta_2 L)\omega^2} \left(-j \frac{\gamma P_0}{\alpha - j\beta_2 \omega^2} - \frac{2\gamma^2 P_0^2}{\alpha(2\alpha - j\beta_2 \omega^2)} \right)$$

Crosstalk variance

- ▷ Current due to crosstalk power after k spans (single segment, receiver noise ignored):

$$\Delta i(t, k) = \rho f(t) * \left(\left| \sqrt{P_0} e^{jk\theta_{SPM}} + mg_k(t - \tau) \right|^2 - P_0 \right)$$

$$\Rightarrow \Delta i(t, k) \approx 2\rho\sqrt{P_0}mf(t) * \left(g_k^{I+}(t - \tau)e^{j\varphi} + g_k^{I-}(t - \tau)e^{-j\varphi} \right)$$

- ▷ $\sigma_x^2(t, k)$ is the variance of $\Delta i(t, k)$ sampled at $t = T_b/2$

$$\sigma_x^2 = 4\rho^2 P_0 \int_{-\infty}^{\infty} \frac{1}{T_b} |f(t) * g_k^{I+}(t - \tau)|^2 d\tau$$

Crosstalk variance: continued

$$\sigma_x^2 = 4\rho^2 P_0 \int_{-\infty}^{\infty} \frac{1}{T_b} |f(t) * g_k^{I+}(t - \tau)|^2 d\tau$$

- ▷ Accounting for modulation: in the variance above, replace P_0 by μ_1 from the short simulation
- ▷ Multisegment case: add crosstalk variances for each crosstalk component coming from a different OXC
- ▷ Complexity:
 - analysis is simpler than even the short simulation
 - short simulation: 32 bits
 - complete simulation: 2048 x 32 bits

Overview

- ▷ Introduction
- ▷ Analysis
- ▷ **Validation by simulation**
- ▷ Conclusion

Validation: physical parameters

Description	Baseline Value
Span length	100 km
Pump power	2 mW
Bit rate	10 Gbps
Pulse shape	NRZ
Crosstalk attn. (power)	-30 dB
Crosstalk detuning	0 GHz
Fiber loss	0.2 dB/km
Nonlinear coefficient	$2.2 (\text{W km})^{-1}$
2 nd order dispersion	17 ps/nm/km
Noise figure	no noise
Dispersion compensation	100% post
Photodetector reponsitivity	1 A/W (arbitrarily)
Electrical filter bandwidth	0.7 x bit rate

▷ Red: analysis - Black: simulation

10 Gbps dispersion-compensated network

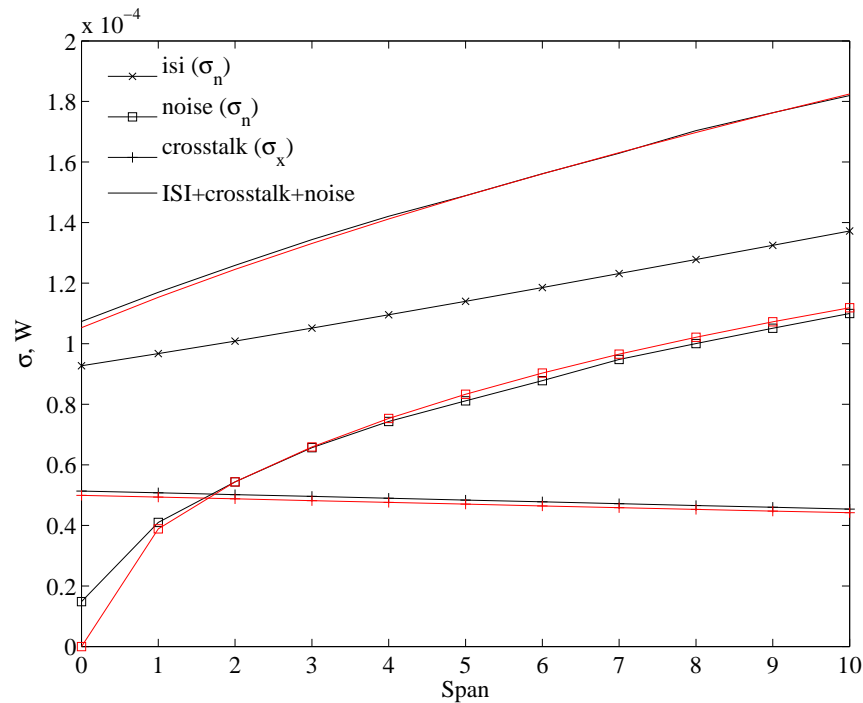

Standard deviations

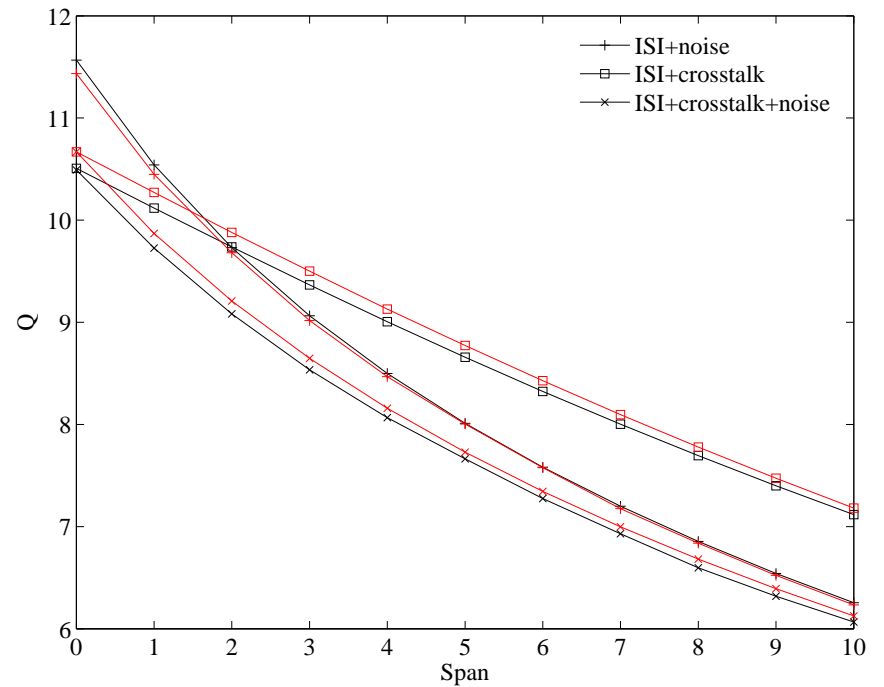

Q factors

2.5 Gbps non dispersion-compensated network

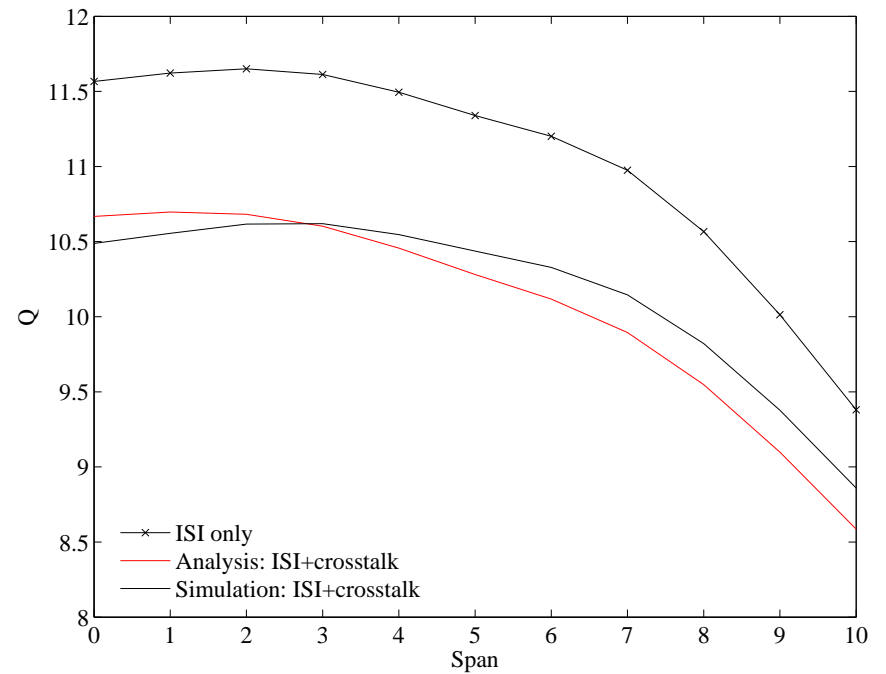
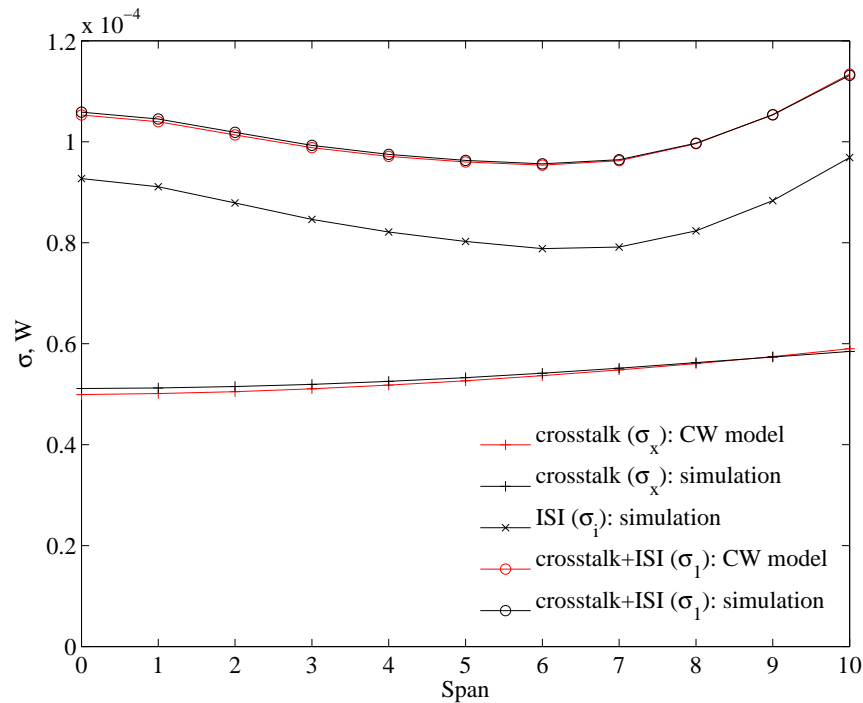

Main signal power and crosstalk attenuation

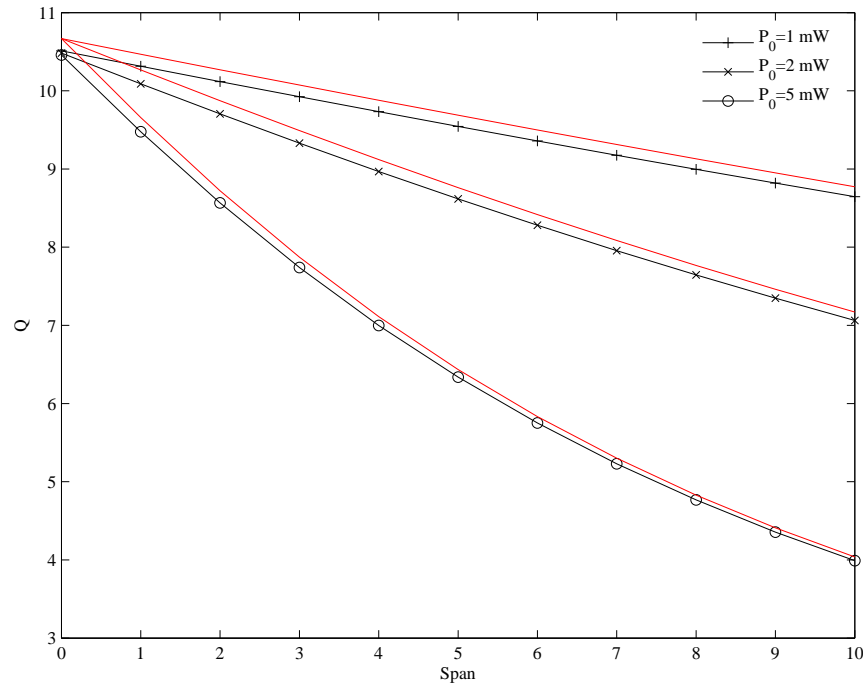

Main signal power

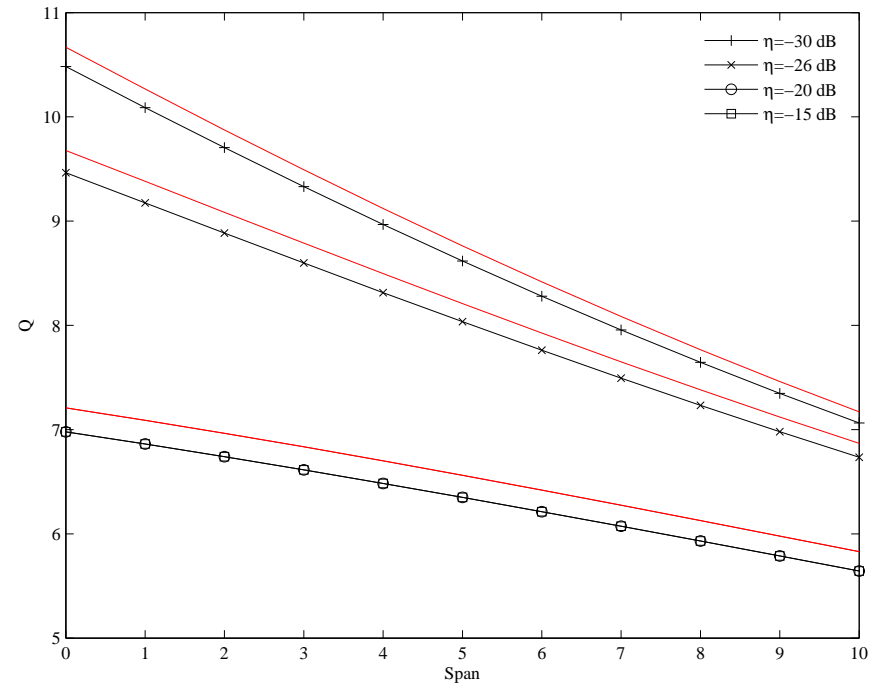

Crosstalk attenuation

Detuning and multisegment

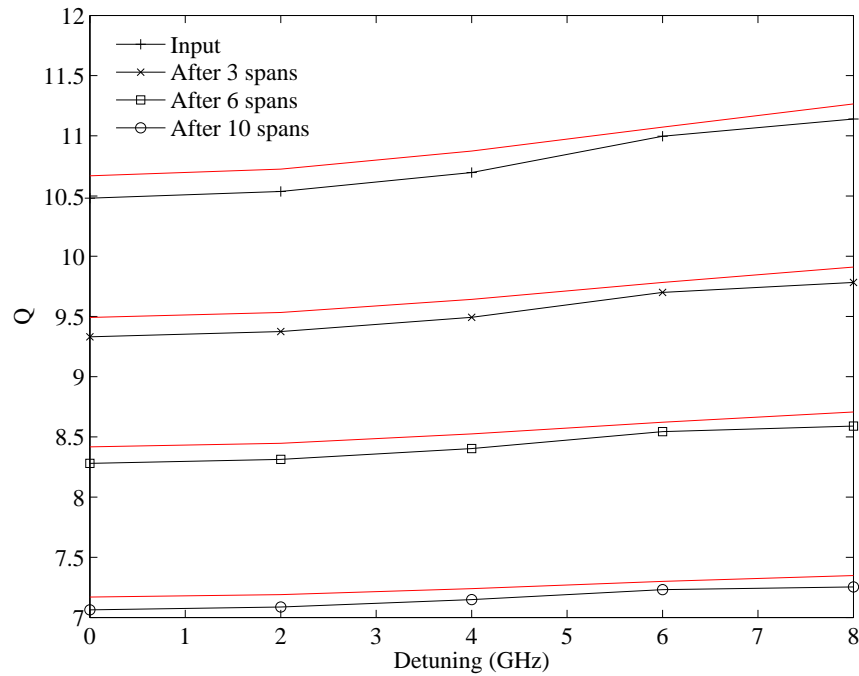

Detuning

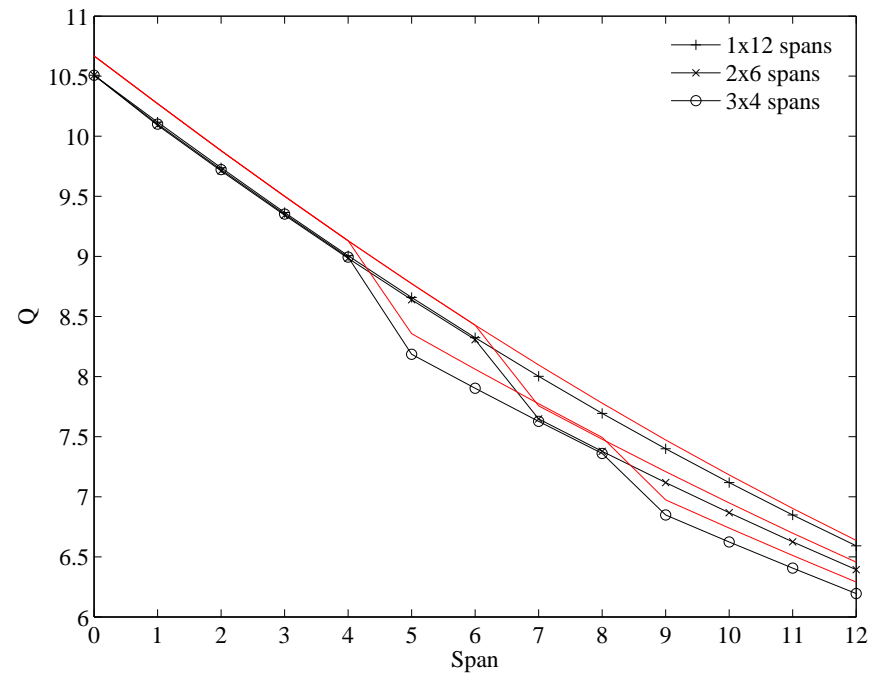

Multisegment

Conclusions: modeling of crosstalk effects

- ▷ Able to assess accurately Q over broad ranges of physical parameters
- ▷ Crosstalk effect cannot be ignored
- ▷ Crosstalk effect may not be constant along a lightpath
- ▷ Current work: crosstalk-aware RWA algorithms